



2SB1202

PNP PLANAR TRANSISTOR

HIGH CURRENT SWITCHING APPLICATION

DESCRIPTION

The UTC 2SB1202 applies to voltage regulators, relay drivers, lamp drivers, and electrical equipment.

FEATURES

- * Adoption of FBET, MBIT processes
- * Large current capacity and wide ASO
- * Low collector-to-emitter saturation voltage
- * Fast switching speed

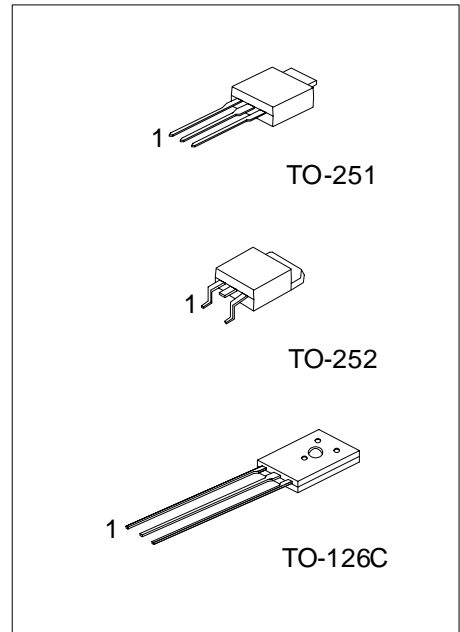

*Pb-free plating product number: 2SB1202L

ORDERING INFORMATION

Order Number		Package	Pin Assignment			Packing
Normal	Lead Free Plating		1	2	3	
2SB1202-x-T6C-K	2SB1202L-x-T6C-K	TO-126C	E	C	B	Bulk
2SB1202-x-TM3-T	2SB1202L-x-TM3-T	TO-251	B	C	E	Tube
2SB1202-x-TN3-R	2SB1202L-x-TN3-R	TO-252	B	C	E	Tape Reel
2SB1202-x-TN3-T	2SB1202L-x-TN3-T	TO-252	B	C	E	Tube

<p>2SB1202L-x-T6C-K</p> <p>(1)Packing Type</p> <p>(2)Package Type</p> <p>(3)Rank</p> <p>(4)Lead Plating</p>	<p>(1) K: Bulk, T: Tube, R: Tape Reel</p> <p>(2) T6C: TO-126C, TM3: TO-251, TN3: TO-252</p> <p>(3) x: refer to Classification of h_{FE1}</p> <p>(4) L: Lead Free Plating, Blank: Pb/Sn</p>
---	---

■ ABSOLUTE MAXIMUM RATINGS (Ta=25°C, unless otherwise specified)

PARAMETER	SYMBOL	RATINGS	UNIT
Collector-Base Voltage	V_{CBO}	-60	V
Collector-Emitter Voltage	V_{CEO}	-50	V
Emitter-Base Voltage	V_{EBO}	-6	V
Collector Power Dissipation	Ta=25°C	1	W
	Tc=25°C	15	W
Collector Current	DC	I_C	-3
	PULSE	I_{CP}	-6
Junction Temperature	T_J	150	°C
Storage Temperature	T_{STG}	-55 ~ +150	°C

Note: Absolute maximum ratings are those values beyond which the device could be permanently damaged. Absolute maximum ratings are stress ratings only and functional device operation is not implied.

■ ELECTRICAL CHARACTERISTICS (Ta=25°C, unless otherwise specified)

PARAMETER	SYMBOL	TEST CONDITIONS	MIN	TYP	MAX	UNIT
C-B Breakdown Voltage	BV_{CBO}	$I_C = -10\mu A, I_E = 0$	-60			V
C-E Breakdown Voltage	BV_{CEO}	$I_C = -1mA, R_{BE} = \infty$	-50			V
E-B Breakdown Voltage	BV_{EBO}	$I_E = -10\mu A, I_C = 0$	-6			V
Collector Cutoff Current	I_{CBO}	$V_{CB} = -40V, I_E = 0$			-1	μA
Emitter Cutoff Current	I_{EBO}	$V_{EB} = -4V, I_C = 0$			-1	μA
C-E Saturation Voltage	$V_{CE(SAT)}$	$I_C = -2A, I_B = -100mA$		-0.35	-0.7	V
B-E Saturation Voltage	$V_{BE(SAT)}$	$I_C = -2A, I_B = -100mA$		-0.94	-1.2	V
DC Current Gain	h_{FE1}	$V_{CE} = -2V, I_C = -100mA$	100		560	
	h_{FE2}	$V_{CE} = -2V, I_C = -3A$	35			
Gain-Bandwidth Product	f_T	$V_{CE} = -10V, I_C = -50mA$		150		MHz
Output Capacitance	C_{ob}	$V_{CB} = -10V, f = 1MHz$		39		pF
Turn-on Time	t_{ON}	See test circuit		70		ns
Storage Time	t_{STG}	See test circuit		450		ns
Fall Time	t_F	See test circuit		35		ns

■ CLASSIFICATION OF h_{FE1}

RANK	R	S	T	U
RANGE	100-200	140-280	200-400	280-560

2SB1202

PNP PLANAR TRANSISTOR

- TEST CIRCUIT FOR NPN (PNP: the polarity is reversed; Unit: resistance: Ω , capacitance: F)

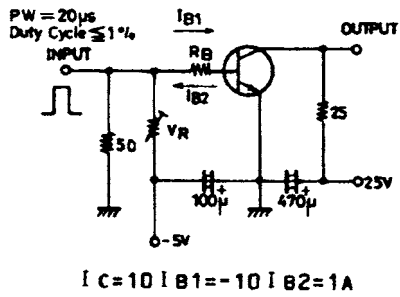

TYPICAL CHARACTERISTICS

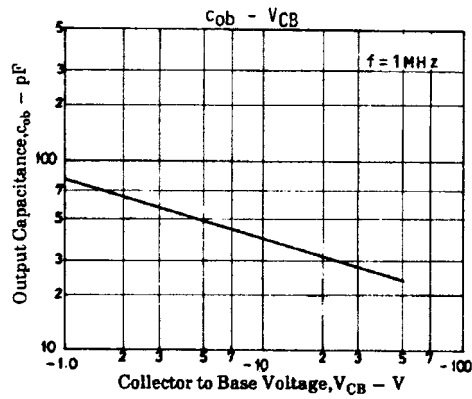
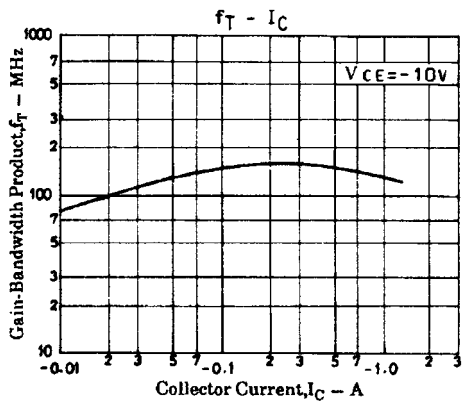
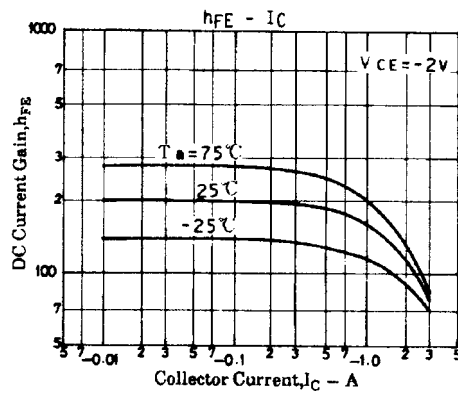
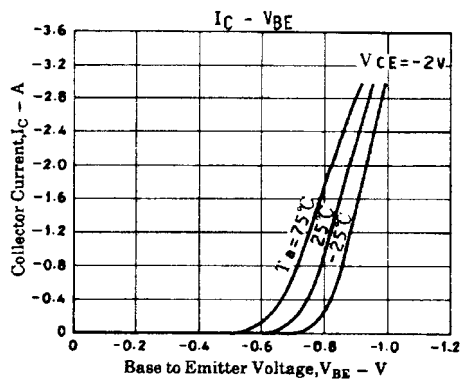
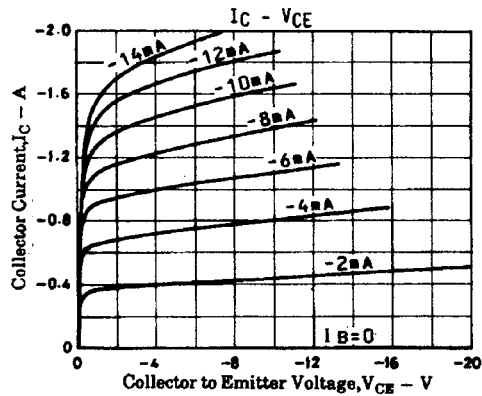
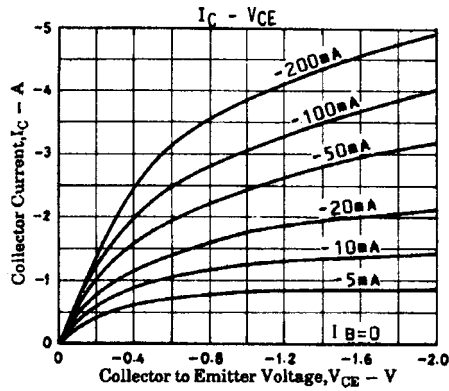

■ TYPICAL CHARACTERISTICS(Cont.)

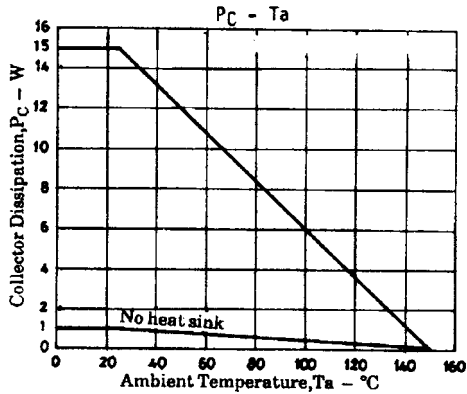
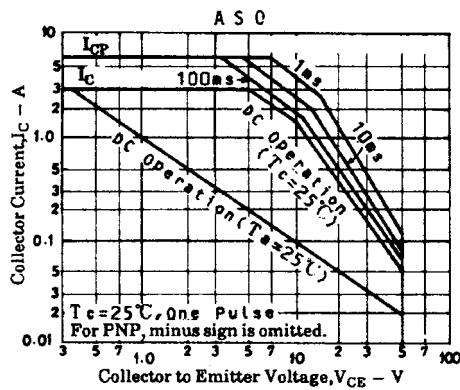
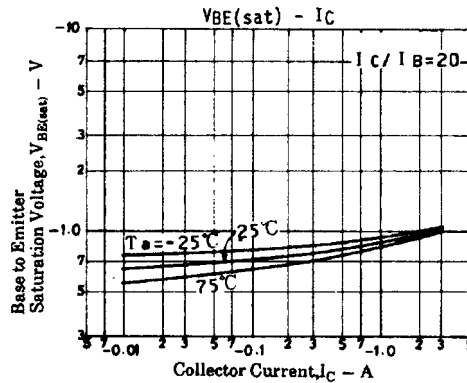
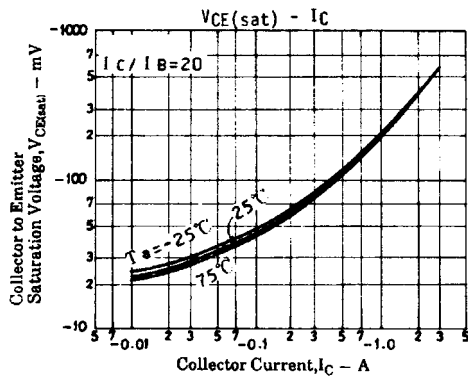

UTC assumes no responsibility for equipment failures that result from using products at values that exceed, even momentarily, rated values (such as maximum ratings, operating condition ranges, or other parameters) listed in products specifications of any and all UTC products described or contained herein. UTC products are not designed for use in life support appliances, devices or systems where malfunction of these products can be reasonably expected to result in personal injury. Reproduction in whole or in part is prohibited without the prior written consent of the copyright owner. The information presented in this document does not form part of any quotation or contract, is believed to be accurate and reliable and may be changed without notice.